

Description

The P8BC03 is Sonion's next generation high performance MEMS microphone. Due to the upgraded sensor, the P8BC03 has improved SNR and is not sensitive to modulated light. The high electro-acoustic performance and tiny package volume (8.2 mm³), combined with the benefits of MEMS technology, make the P8BC03 the best microphone choice for hearing aids.

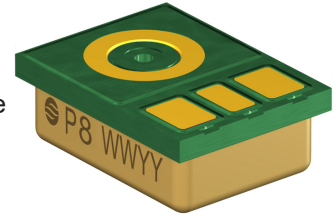

Features

- Small surface-mount package: 3.35x2.50x0.98 mm
- Reflow compatibility
- Stable response curve with humidity
- Not sensitive to modulated light
- Non-inverting transfer
- Compatibility with p2i nanocoating process

Product drawing - Dimensions in mm [inch]

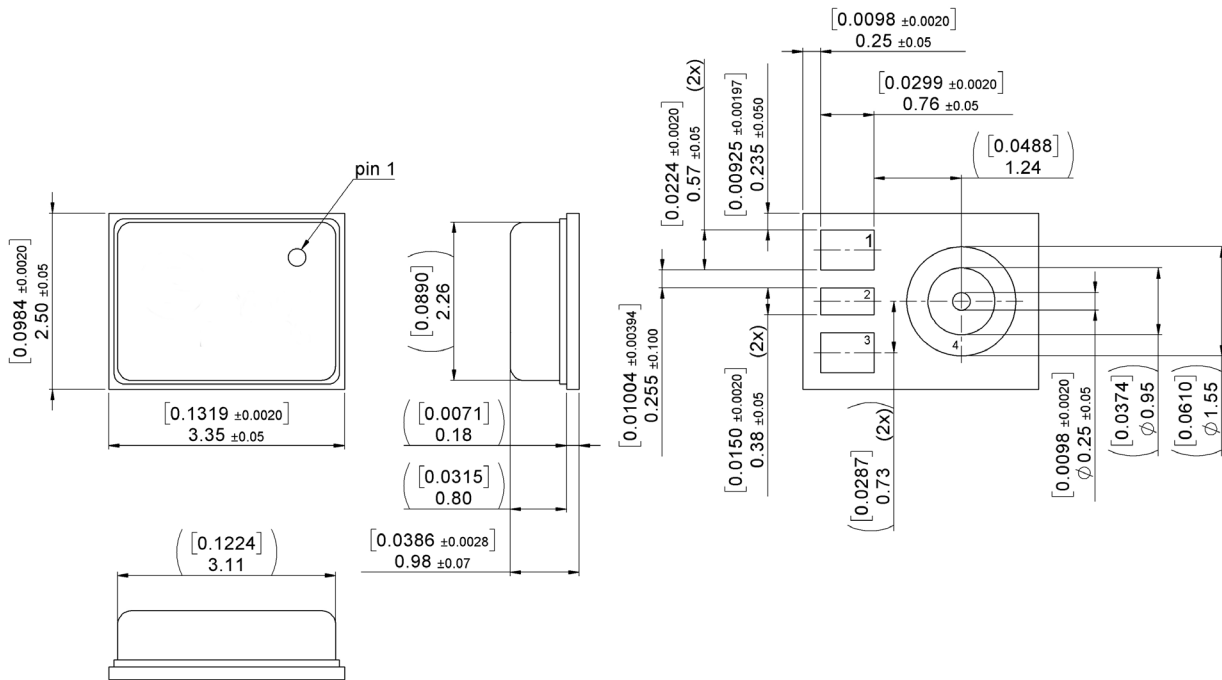

Pin configuration

1. Output: Analog output signal
2. GND: Ground*
3. VDD: Power supply
4. GND: Ground*

* Pin 2 and Pin 4 should both be grounded

Sonion reserves the right to make changes at any time to improve reliability, function or design, in order to provide the best product possible.

Specifications

All parameters are specified at 0.9 V and 1 MOhm // <200pF load impedance, AC-coupled with 1μF, unless specified otherwise. Environmental conditions: 23°C (73.4F), 50% RH.

Parameters	Min	Typ	Max	Unit	Comments	
Sensitivity	@ 60 Hz	-5	-3	-2	dB	re. 1 kHz value
	@ 1 kHz	-37.5	-36.5	-35.5	dB	re. 1V per Pascal
	@ 10 kHz	-1	1	4	dB	re. 1 kHz value
	@ 25 kHz		-10	-5	dB	re. 1 kHz value
	@ 32 kHz		-17	-12	dB	re. 1 kHz value
Resonant peak	frequency	15	16	17	kHz	
	amplitude		9	12.5	dB	re. 1 kHz value
Equivalent noise (A-weighted)	10 Hz- 8 kHz		24.5	26	dB SPL	
	10 Hz-20 kHz		26	28.5	dB SPL	
1/3 Octave equivalent input noise			12.5	14.5	dB SPL	@ 1 kHz
Power supply feedthrough			-42	-35	dB	
Battery voltage range		0.88	0.9	1.4	VDC	absolute maximum 2.1 VDC
Battery drain			32	35	μA	
Output impedance @ 1 kHz		3	4.5	5.5	kOhm	with integrated 4.7nF capacitor
DC output voltage		350	450	550	mV	
Maximum input level @ 1 kHz		117	118		dB SPL	5% THD
Startup time			0.25	1	sec	to within 0.5 dB of final sens.
				5	sec	to within 0.1 dB of final sens.
Peak battery drain at startup			150		μA	for ~2.5μs duration *
Recovery time from overload				1	sec	to within 0.5 dB of final sens.
				5	sec	to within 0.1 dB of final sens.
Input-referred vibration sensitivity			66	68	dB SPL/g	@ 1 kHz
Humidity coefficient of sensitivity				0.005	dB/%RH	
Input-referred EMI noise	0.7-0.96 Ghz			25	dB SPL	according to IEC 60118-13 Ed 4.0 and with pin 4 grounded
	1.4-2.0 GHz			25	dB SPL	
	2.0-2.7 GHz			25	dB SPL	
Operating temperature range		-10		65	°C	
Storage temperature range		-55		150	°C	
ESD protection level: Class 2 according to MIL-STD-750D, test method 1020,2						
Apply protection in accordance with IEC 61340-5-1 and 61340-5-2.						
* Details in application note: Sonion Microphone O&P Startup Behavior - AN rev0xx						

Mechanical data

Weight	0.016 gr
Package type	4-Terminal LGA + Metal lid
Lid	Ni/Au, SS304
Substrate	Ni/Au, 4L RC
Solder pad content	Cu/Ni/Au

Sonion reserves the right to make changes at any time to improve reliability, function or design, in order to provide the best product possible.

Typical response curve

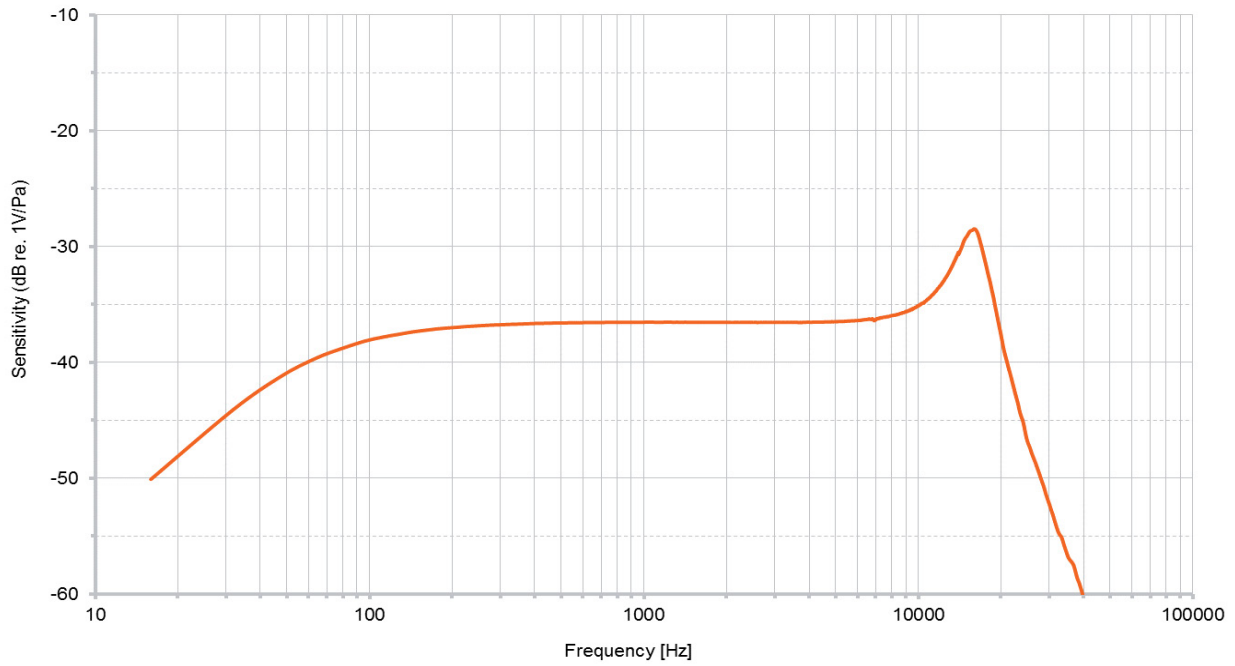

Typical 1/3 octave equivalent noise

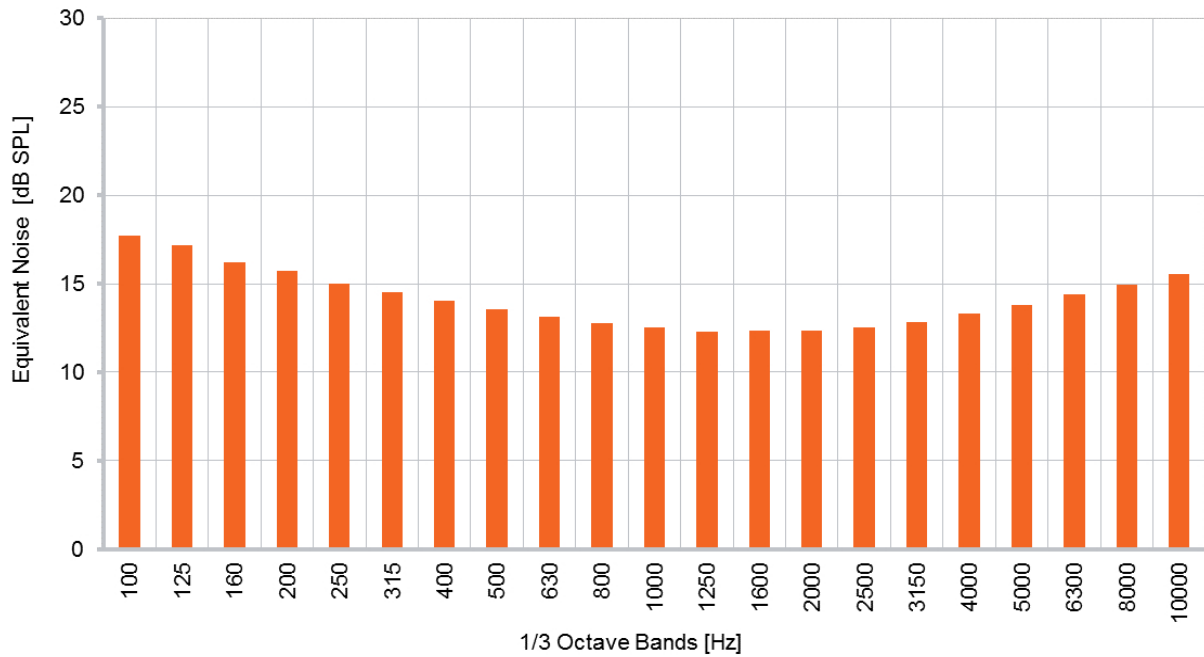

Sonion reserves the right to make changes at any time to improve reliability, function or design, in order to provide the best product possible.

Packaging - Dimensions in mm

Reel diameter 180 mm (7 inch)

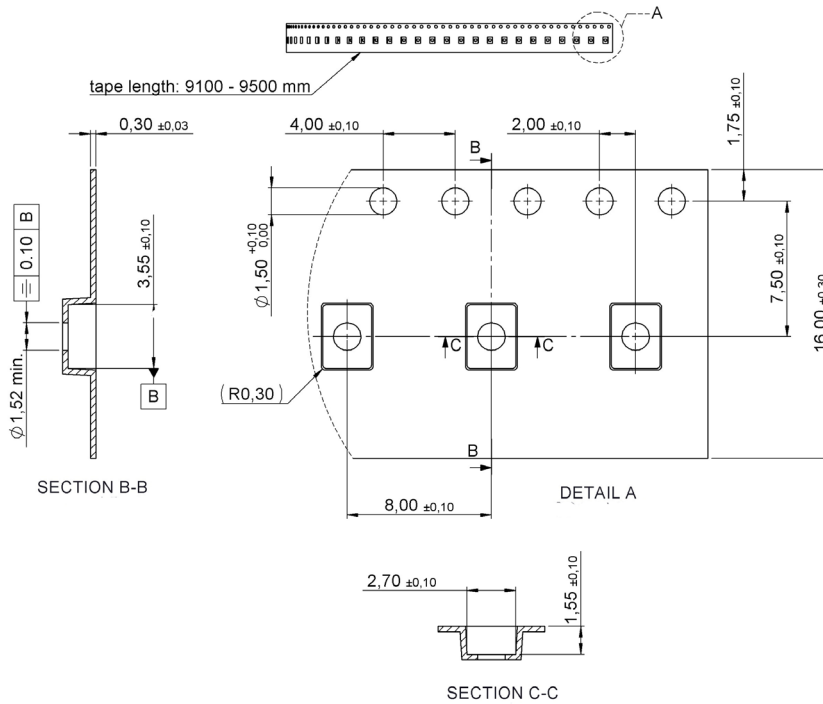

Packaging - Product orientation

Maximum quantity per reel 1000

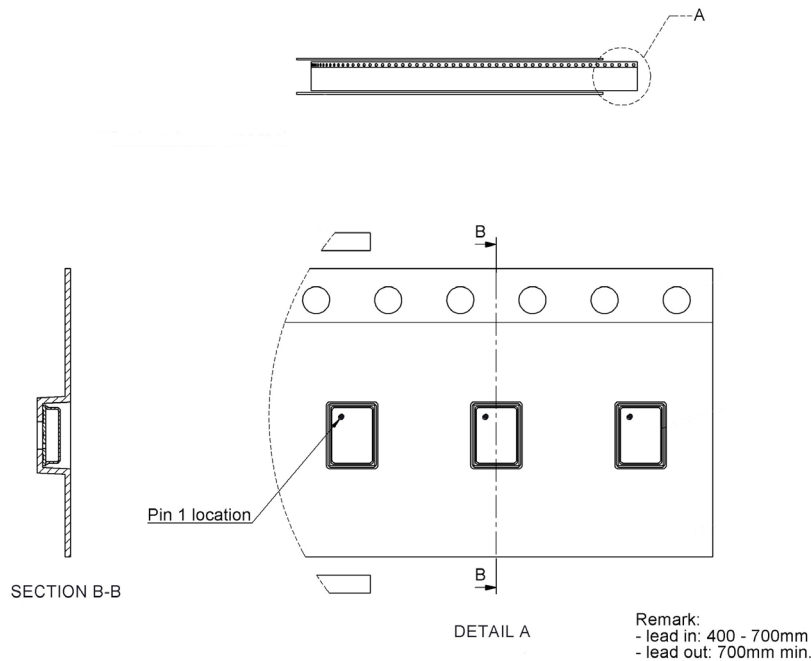
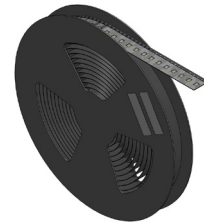

Note: Packaging MSL (Moisture Sensitivity Level) Class1. Tape and Reel in according with EIA-481

Sonion reserves the right to make changes at any time to improve reliability, function or design, in order to provide the best product possible.