

Description

The O8BC03 is a high performance MEMS microphone with a unique combination of very low self-noise, tiny package volume (8.2 mm³), and low power consumption. These features, combined with the benefits of MEMS technology, reflow solder compatibility, and a highly stable response over time and temperature, make the O8BC03 an ideal microphone choice for hearing aids.

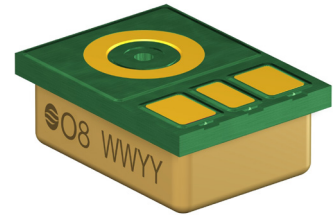

Features

- Small surface-mount package: 3.35x2.50x0.98 mm
- Reflow compatibility
- Stable response curve with humidity
- Non-inverting transfer
- Compatibility with p2i nanocoating process

Product drawing - Dimensions in mm [inch]

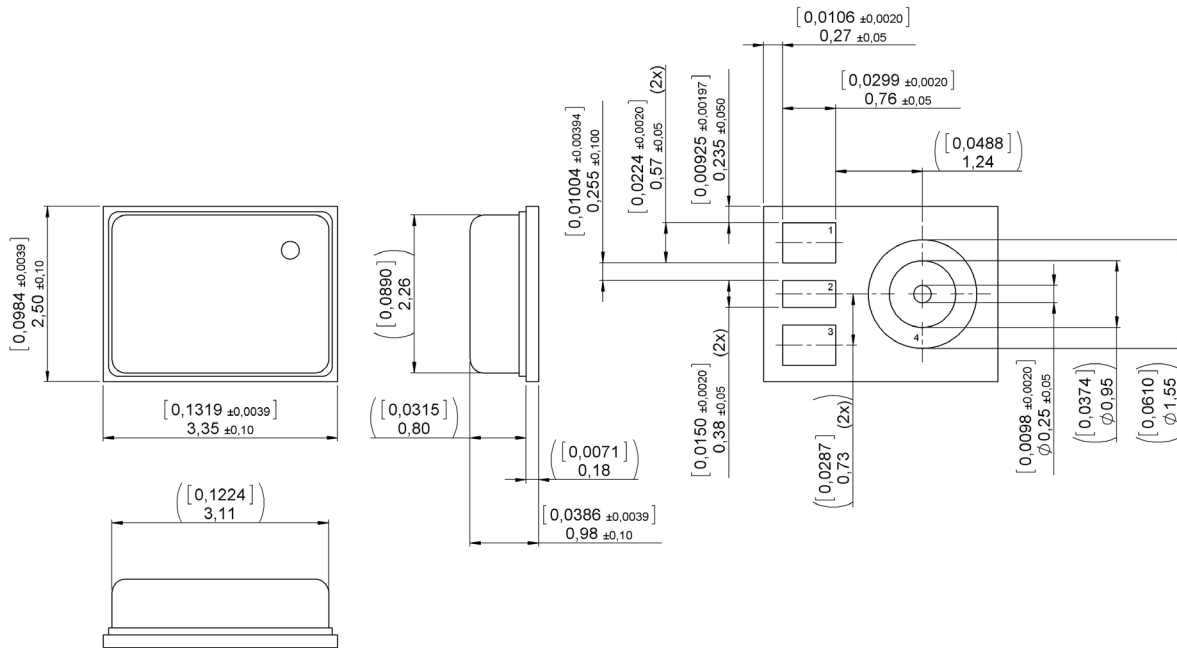

Pin configuration

1. Output: Analog output signal
2. GND: Ground*
3. VDD: Power supply
4. GND: Ground*

* Pin 2 and Pin 4 should both be grounded

Sonion reserves the right to make changes at any time to improve reliability, function or design, in order to provide the best product possible.

Specifications

All parameters are specified at 0.9 V and 1 MOhm // <200pF load impedance, AC-coupled with 1μF, unless specified otherwise. Environmental conditions: 23°C (73.4F), 50% RH.

Parameters		Min	Typ	Max	Unit	Comments
Sensitivity	@ 70 Hz	-5	-3	-2	dB	re. 1 kHz value
	@ 1 kHz	-39	-38	-37	dB	re. 1V per Pascal
	@ 10 kHz	-4	0	2	dB	re. 1 kHz value
	@ 25 kHz	-15	-10	-7	dB	re. 1 kHz value
	@ 32 kHz	-23.5	-18.5	-15	dB	re. 1 kHz value
Resonant peak	frequency	16	17	18	kHz	
	amplitude		7.5	10.5	dB	re. 1 kHz value
Equivalent noise (A-weighted)	10 Hz- 8 kHz		25.5	26.5	dB SPL	
	10 Hz-20 kHz		26.5	27.5	dB SPL	
1/3 Octave equivalent input noise			13.5	14.5	dB SPL	@ 1 kHz
Power supply feedthrough			-42	-35	dB	
Battery voltage range		0.88	0.9	1.4	VDC	absolute maximum 2.1 VDC
Battery drain			31	35	μA	
Output impedance		3	4.5	5.5	kOhm	with integrated 4.7nF cap.
DC output voltage		350	450	550	mV	
Maximum input level @ 1 kHz		119	120		dB SPL	5% THD
Startup time			0.25	1	sec	to within 0.5 dB of final sens.
				5	sec	to within 0.1 dB of final sens.
Peak battery drain at startup			150		μA	for ~2.5μs duration *
Recovery time from overload				1	sec	to within 0.5 dB of final sens.
				5	sec	to within 0.1 dB of final sens.
Input-referred vibration sensitivity			65	67	dB SPL/g	@ 1 kHz
Humidity coefficient of sensitivity				0.005	dB/%RH	
Input-referred EMI noise	0.7-0.96 Ghz			25	dB SPL	according to IEC 60118-13 Ed 4.0 and with pin 4 gounded
	1.4-2.0 GHz			25	dB SPL	
	2.0-2.7 GHz			25	dB SPL	
Operating temperature range		-10		65	°C	
Storage temperature range		-55		150	°C	
ESD protection level: Class 2 according to MIL-STD-750D, test method 1020,2						
Apply protection in accordance with IEC 61340-5-1 and 61340-5-2.						
* Details in application note: Sonion Microphone O&P Startup Behavior - AN rev0xx						

Mechanical data

Weight	0.016 gr.
Package type	4-Treminal LGA + Metal lid
Lid	Ni/Au, SS304
Substrate	Ni/Au, 4L RC
Solder pad content	Cu/Ni/Au

Sonion reserves the right to make changes at any time to improve reliability, function or design, in order to provide the best product possible.

Typical response curve

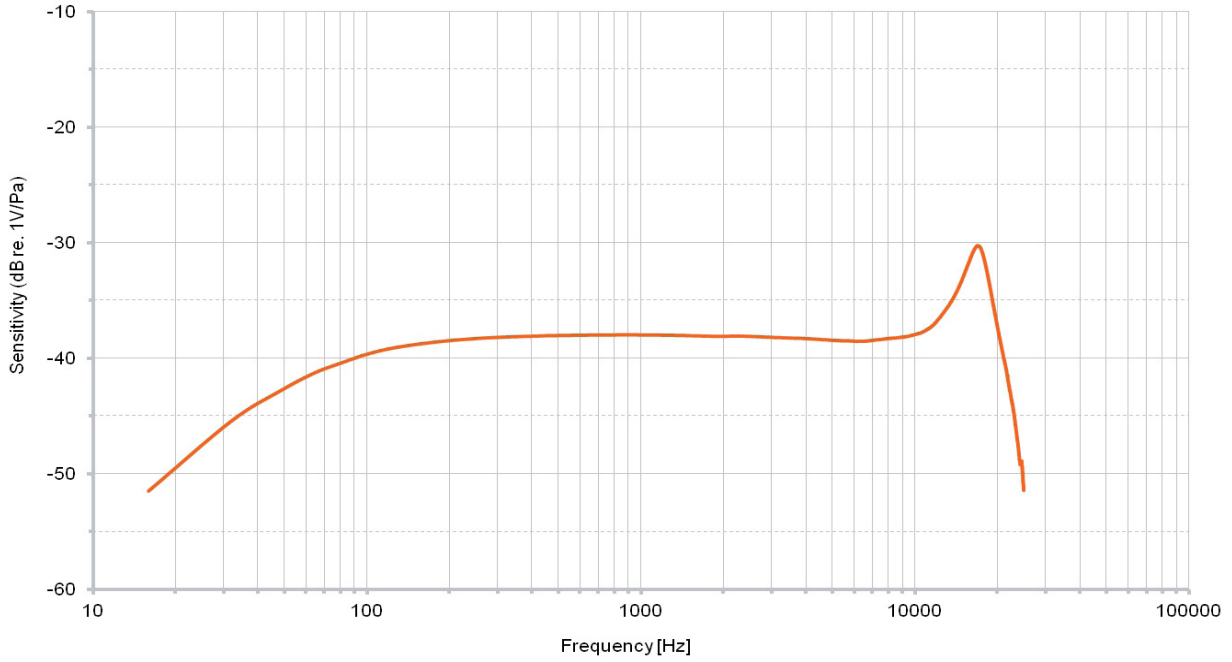

Typical 1/3 octave equivalent noise

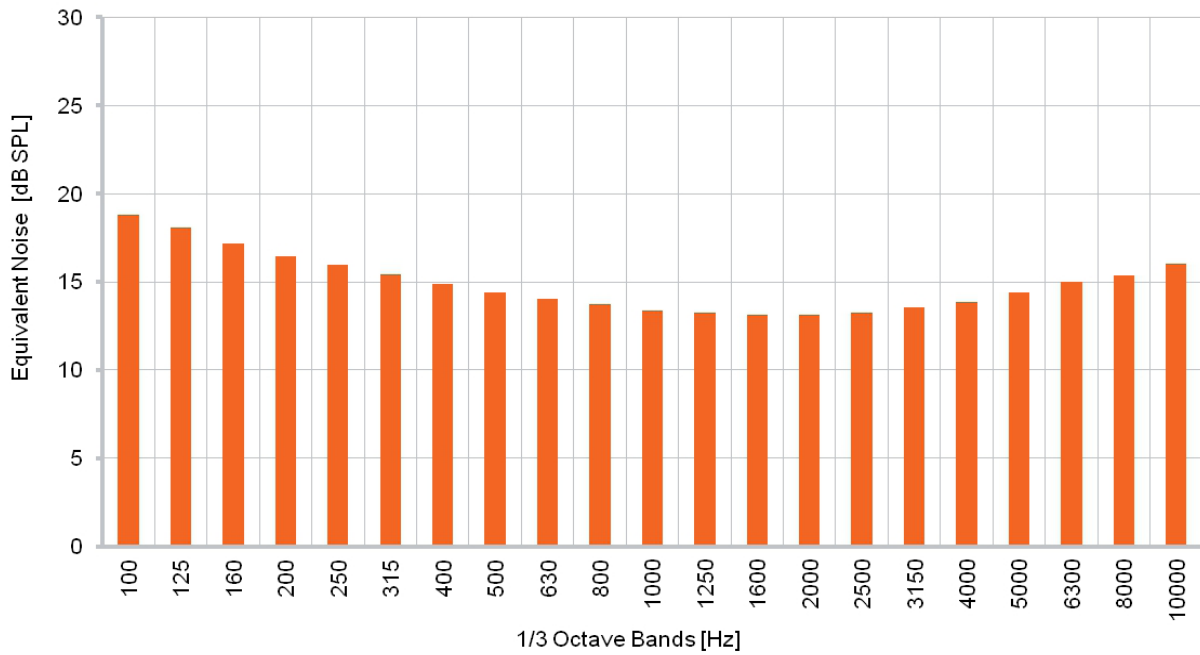

Sonion reserves the right to make changes at any time to improve reliability, function or design, in order to provide the best product possible.

Packaging - Dimensions in mm

Reel diameter 180 mm (7 inch)

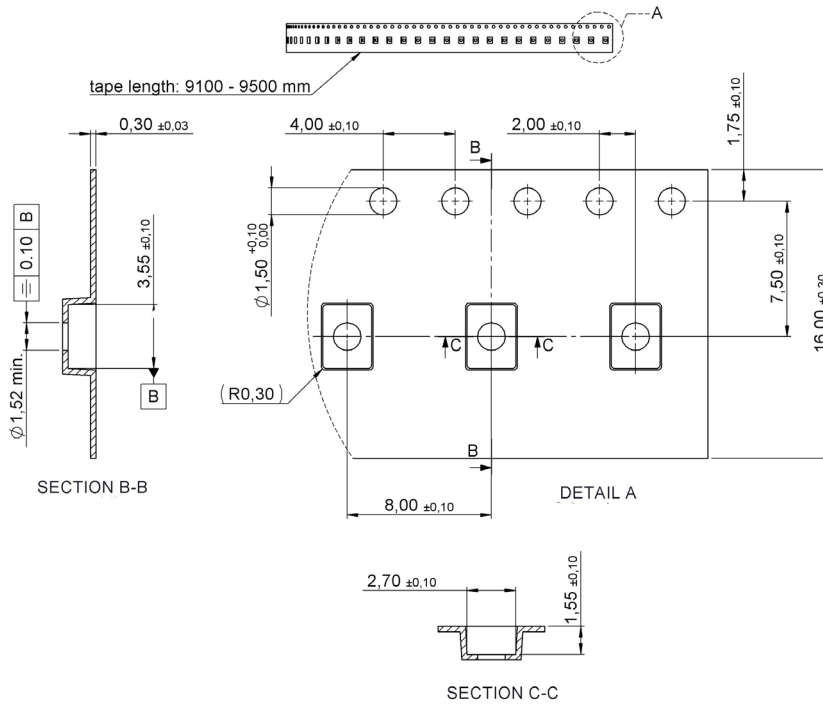

Packaging - Product orientation

Quantity per reel 1000

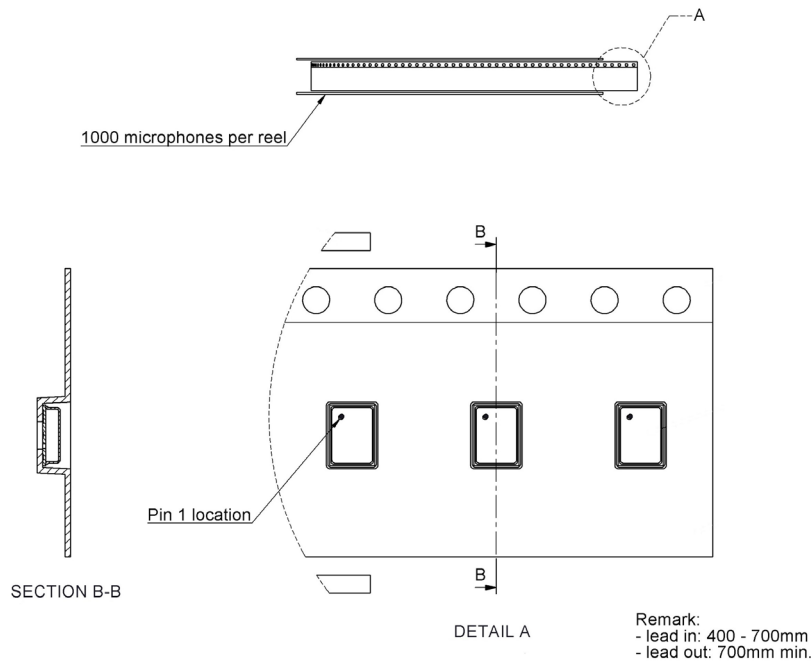
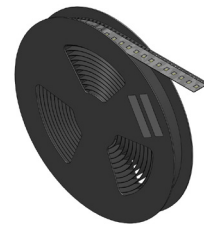

Notes: Packaging MSL (Moisture Sensitivity Level) Class 1. Tape and Reel in accordance with EIA-481.

Sonion reserves the right to make changes at any time to improve reliability, function or design, in order to provide the best product possible.