

Description

Subminiature magnetic receiver (Balanced Armature Type) for use in hearing aids.

Features

- Slim design
- High output for size, maximum peak output 113 dB
- Increased resistance provides flat LF response driven from voltage source



Mechanical data

Weight	0.065 gr.
Case material	Ni48Fe52
Solder pad material	Sn96.5Ag3.0Cu0.5
Dimensions	Refer to outline drawing

Product drawing - Dimensions in mm [inch]

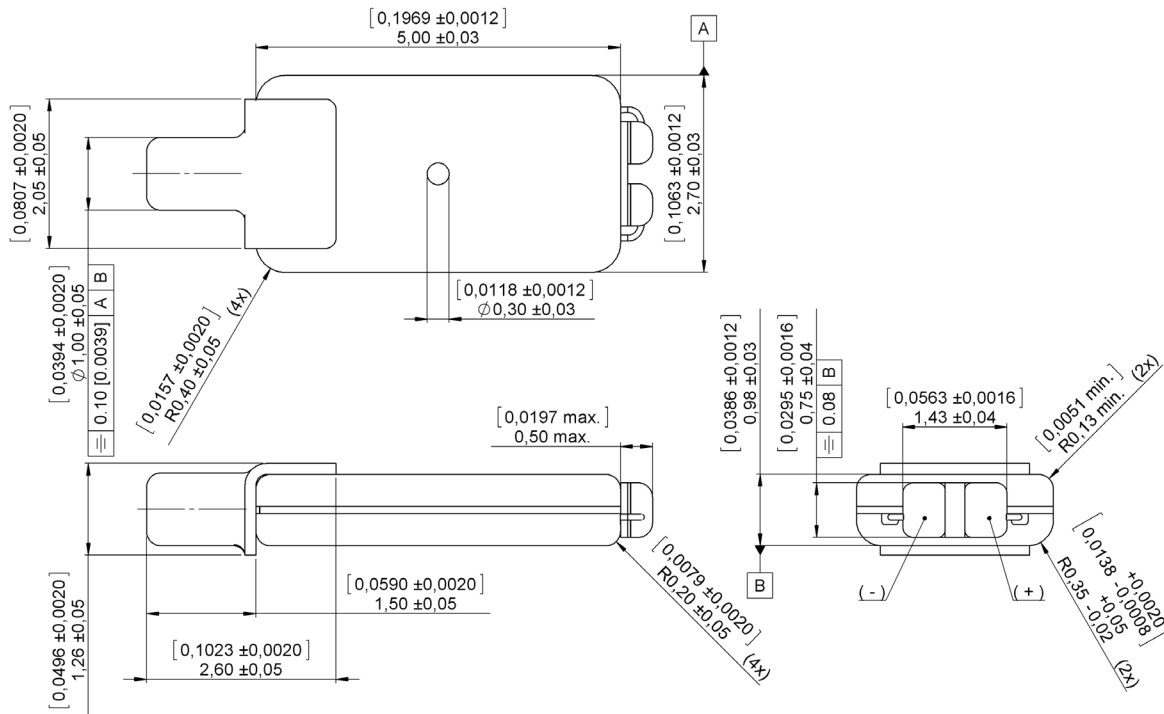

Sonion reserves the right to make changes at any time to improve reliability, function or design, in order to provide the best product possible. Receivers series of this type can produce very high sound pressure levels. When such receivers are applied in hearing instruments or other communications equipment special attention should be paid to this capacity in order to prevent possible hearing damage.

Specifications

Acoustic loading: 10 mm x 1.0 mm ID into a 2 cc coupler versus 10 mm x 1.0 mm ID into a IEC 711 coupler. Constant voltage drive of 0.15 V RMS (0.35 mVA @ 500 Hz).

Environmental conditions: 23°C (73.4F), 50 % RH

Acoustic parameters		10x1mm into 2cc			10x1mm into 711			Unit	Comments
		Min	Typ	Max	Min	Typ	Max		
Sensitivity	@ 200 Hz	91.5	94	96.5	95.5	98	100.5	dB	
	@ 500 Hz	91	93.5	96	95	97.5	100	dB	
	@ 1000 Hz	90.5	92.5	94.5	95.5	98	100.5	dB	
Peak 1	frequency	3000	3200	3400	3000	3200	3400	Hz	
	output	96	99	102	96	99	102	dB	
Valley 1	frequency	5350	5950	6550	5350	5950	6550	Hz	
	output	81	83		93.5	95.5		dB	
Peak 2	frequency	6600	7200	7800	6600	7200	7800	Hz	
	output	82.5	85	89.5	99	102.5	106	dB	
THD	@ 1/3 peak			5			5	%	
	@ 1/2 peak			5			5	%	
Max outp. @ peak freq.			115			125		dB	@ 50 mVA input

Electric parameters	Min	Typ	Max	Unit	Comments
Impedance @ 1000 Hz	61	76	91	Ohm	
Impedance @ 500 Hz	49	61	73	Ohm	
DC resistance @ 20°C	44	55	66	Ohm	
DC bias current range	zero bias				

Additional parameters	Min	Typ	Max	Unit	Comments
Shock resistance	12000			g	80% survival rate with THD @ 1/2 peak frequency < 10%
Storage temperature range	-40		63	°C	

A positive voltage applied to the negative terminal (-) will result in an increase in pressure at the sound outlet.

Sonion reserves the right to make changes at any time to improve reliability, function or design, in order to provide the best product possible. Receivers series of this type can produce very high sound pressure levels. When such receivers are applied in hearing instruments or other communications equipment special attention should be paid to this capacity in order to prevent possible hearing damage.

Typical response curve

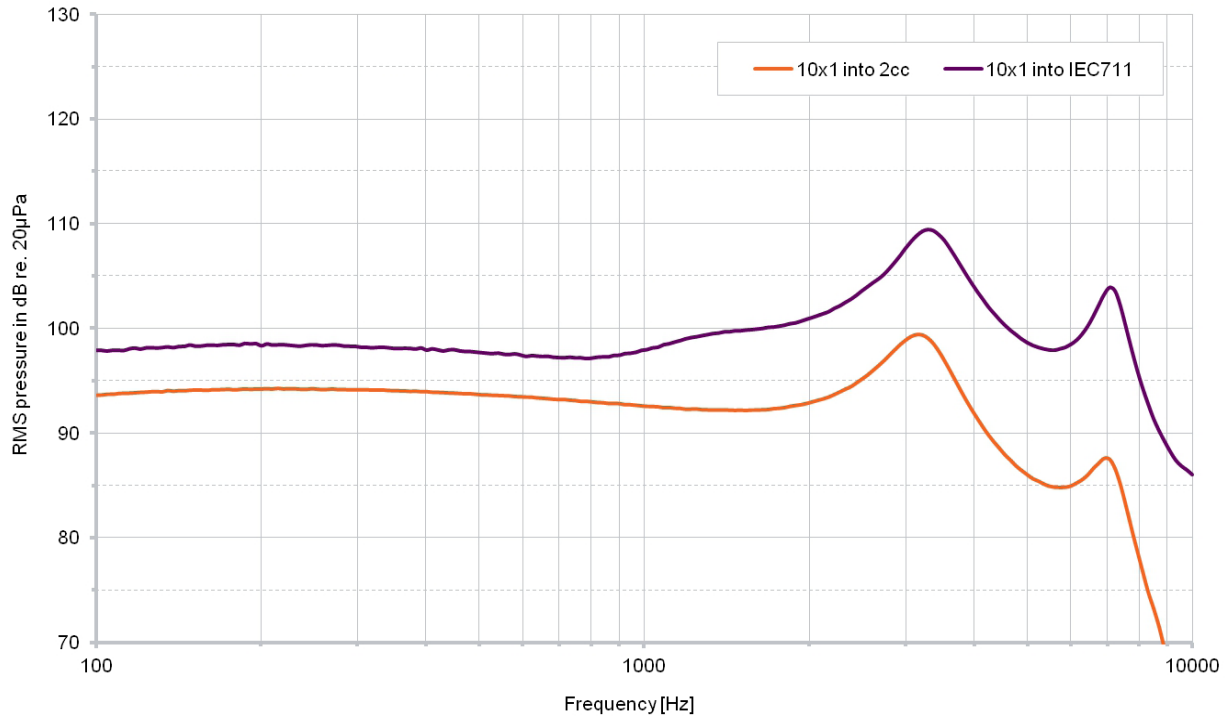

Sonion reserves the right to make changes at any time to improve reliability, function or design, in order to provide the best product possible. Receivers series of this type can produce very high sound pressure levels. When such receivers are applied in hearing instruments or other communications equipment special attention should be paid to this capacity in order to prevent possible hearing damage.